



# CP2510N3A

## 主要参数 MAIN CHARACTERISTICS

$I_T(RMS)$	25A
$V_{DRM}$	800V
$I_{GT}(I,II,III)$	10mA

### 用途

- 交流开关
- 相位控制

### 产品特性

- 平面钝化芯片高可靠性、一致性
- 三象限可控硅，触发电流的一致性好
- 环保 RoHS 产品
- 150℃ 高结温产品

### APPLICATIONS

- AC switching
- Phase control

### FEATURES

- Planar chip for reliability and uniform
- Uniform gate trigger currents in three quadrants
- RoHS products
- 150℃ High operating junction temperature

## 封装 Package

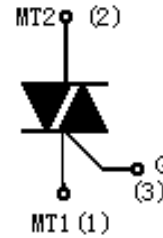

序号 Pin	引线名称 Description
1	主电极 1 MT1
2	主电极 2 MT2
3	门极 G

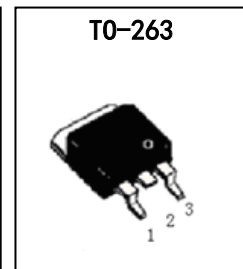
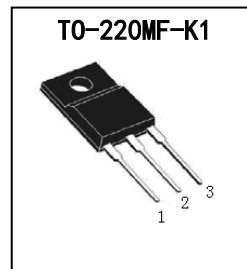
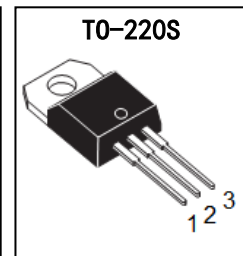
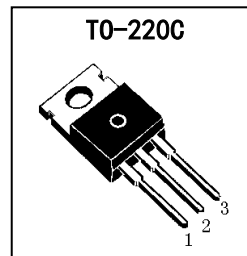

## 订货信息 ORDER MESSAGES

订货型号 Order codes				印 记 Marking	封 装 Package
有卤-条管 Halogen-Tube	无卤-条管 halogen-Free-Tube	有卤-编带 Halogen-Reel	无卤-编带 Halogen-Free-Reel		
CP2510N3A-C-B	CP2510N3A-C-BR	N/A	N/A	CP2510N3A	TO-220C
CP2510N3A-CB-B	CP2510N3A-CB-BR	N/A	N/A	CP2510N3A	TO-220S
CP2510N3A-F1-B	CP2510N3A-F1-BR	N/A	N/A	CP2510N3A	TO-220MF-K1
CP2510N3A-S-B	CP2510N3A-S-BR	CP2510N3A-S-A	CP2510N3A-S-AR	CP2510N3A	TO-263

**概述 GENERAL DESCRIPTION**

CP2510N3A是平面芯片结构的三象限双向晶闸管，产品在第四象限不可触发，具有较高的使用可靠性。可适用于容易出现较高dV/dt或dI/dt的交流全波控制线路中，特别推荐应用与电感性负载控制（如电机控制线路）。器件封装形式有TO-220C、TO-220S（引线与散热片绝缘）、TO-220MF-K1（塑料全封装）、TO-263。

CP2510N3A are Planar three quadrant triacs, designed for high performance full-wave ac control applications where high static and dynamic dV/dt and high dI/dt can occur. They are specially recommended for use on inductive loads such as motor control circuits. Available packages are TO-220C、TO-220S (internally insulated) 、TO-220MF-K1 (plastic envelope) and TO-263.

**绝对最大额定值 ABSOLUTE RATINGS (T<sub>c</sub>=25℃)**

项 目 Parameter	符 号 Symbol	试 验 条 件 Condition	数 值 Value	单 位 Unit
重复峰值断态电压 Repetitive peak off-state voltage	V <sub>DRM</sub>		±800	V
通态方均根电流 On-state RMS current	I <sub>T(RMS)</sub>	full sine wave,	25	A
非重复浪涌峰值通态电流 Non-repetitive surge peak on-state current	I <sub>TSM</sub>	full sine wave ,t=20ms	200	A
		full sine wave ,t=16.7ms	210	A
	I <sup>2</sup> t	t=10ms	200	A <sup>2</sup> s
通态电流临界上升率 Repetitive rate of rise of on-state current after triggering	dI/dt	I <sub>TM</sub> =30A, I <sub>G</sub> =0.2A, dI <sub>G</sub> /dt=0.2A/μs	100	A/μs
峰值门极电流 Peak gate current	I <sub>GM</sub>		2	A
峰值门极电压 Peak gate voltage	V <sub>GM</sub>		5	V
峰值门极功率 Peak gate power	P <sub>GM</sub>		5	W
平均门极功率 Average gate power	P <sub>G(AV)</sub>	over any 20ms period	0.5	W
存储温度 Storage temperature	T <sub>stg</sub>		-40~150	℃
操作结温 Operation junction temperature	T <sub>VJ</sub>		150	℃

电特性 ELECTRICAL CHARACTERISTIC (T<sub>c</sub>=25°C)

项 目 Parameter	符 号 Symbol	测 试 条 件 Condition	最小 Min	典型 Typ	最大 Max	单位 Unit	
峰值重复断态电流 Peak Repetitive Blocking Current	I <sub>DRM</sub>	V <sub>DM</sub> =V <sub>DRM</sub> , T <sub>j</sub> =25°C, gate open	-	-	10	μA	
		V <sub>DM</sub> =V <sub>DRM</sub> , T <sub>j</sub> =150°C, gate open	-	-	3.0	mA	
峰值通态电压 Peak on-state voltage	V <sub>TM</sub>	I <sub>TM</sub> =30A	-	-	1.7	V	
门极触发电流 Gate trigger current	I <sub>GT</sub>	V <sub>DM</sub> =12V, R <sub>L</sub> =100Ω	MT1(-),MT2(+),G(+)	-	-	10	mA
			MT1(-),MT2(+),G(-)	-	-	10	mA
			MT1(+),MT2(-),G(-)	-	-	10	mA
门极触发电压 Gate trigger voltage	V <sub>GT</sub>	V <sub>DM</sub> =12V, R <sub>L</sub> =100Ω	MT1(-),MT2(+),G(+)	-	0.7	1.5	V
			MT1(-),MT2(+),G(-)	-	0.7	1.5	V
			MT1(+),MT2(-),G(-)	-	0.7	1.5	V
维持电流 Holding current	I <sub>H</sub>	V <sub>DM</sub> =12V, I <sub>GT</sub> =0.1A	-	-	25	mA	
擎住电流 Latching current	I <sub>L</sub>	V <sub>DM</sub> =12V, I <sub>GT</sub> =0.1A	MT1(-),MT2(+),G(+)	-	-	25	mA
			MT1(-),MT2(+),G(-)	-	-	30	mA
			MT1(+),MT2(-),G(-)	-	-	30	mA
断态临界电压上升率 Rise of off- state voltage	dV/dt	V <sub>DM</sub> =67% V <sub>DRM(MAX)</sub> , T <sub>j</sub> =150°C, gate open	10	-	-	V/μs	
门极开通时间 Gate controlled turn-on time	t <sub>gt</sub>	I <sub>TM</sub> =30A, V <sub>DM</sub> =V <sub>DRM(MAX)</sub> , I <sub>G</sub> =0.1A, di <sub>G</sub> /dt=5A/μs	-	2	-	μs	

## 热特性 THERMAL CHARACTERISTIC

项 目 Parameter	符 号 Symbol	条 件 Condition	最小 Min	典型 Typ	最大 Max	单位 Unit
结到管壳的热阻 Thermal resistance junction to case	R <sub>th(j-c)</sub>	full cycle(TO-220C)			1.0	°C/W
		full cycle(TO-220S)			2.0	°C/W
		full cycle(TO-220MF-K1)			3.2	°C/W
		full cycle(TO-263)			1.0	°C/W

## 电绝缘特性 ELECTRICAL ISOLATION

项 目 Parameter	符 号 Symbol	条 件 Condition	数 值 Value	单 位 Unit
绝缘电压 Isolation voltage	V <sub>ISOL</sub>	1 minute, leads to mounting tab TO-220S/TO-220MF-K1	2000	V



特征曲线 ELECTRICAL CHARACTERISTICS (curves)

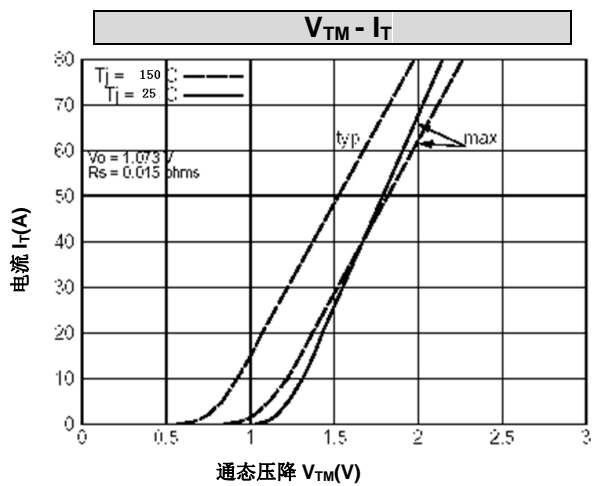
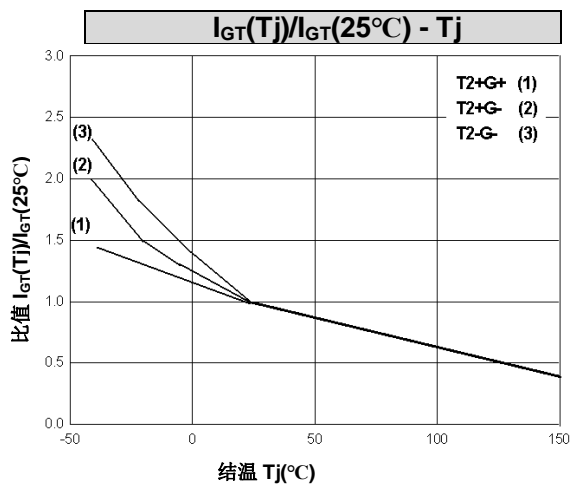
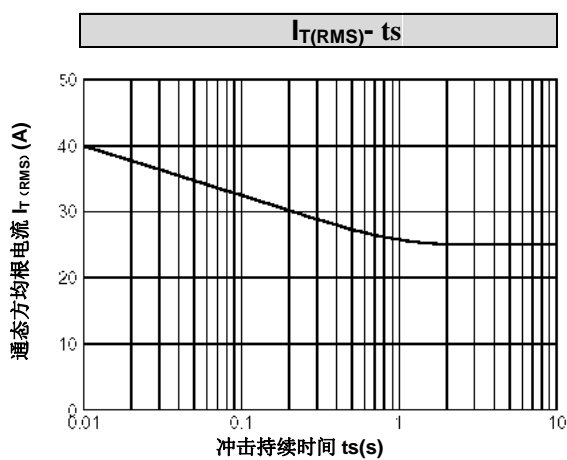
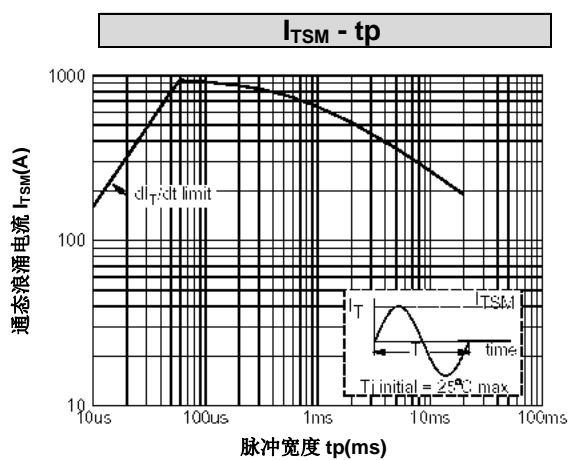
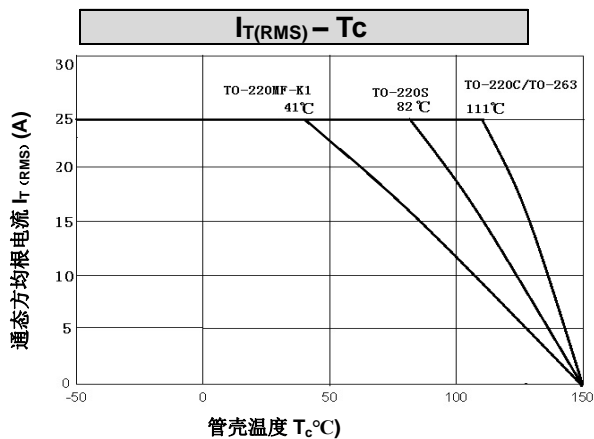
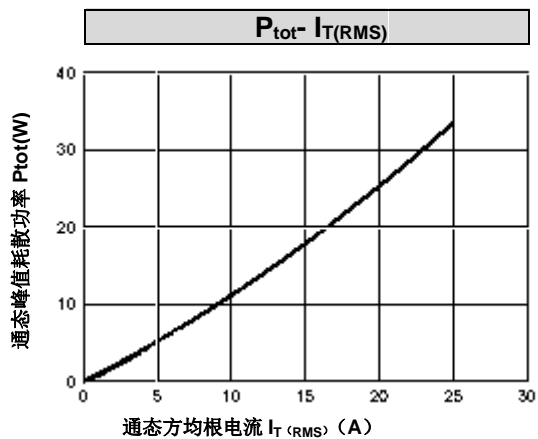



## 外形尺寸 PACKAGE MECHANICAL DATA

TO-220C

单位 Unit : mm

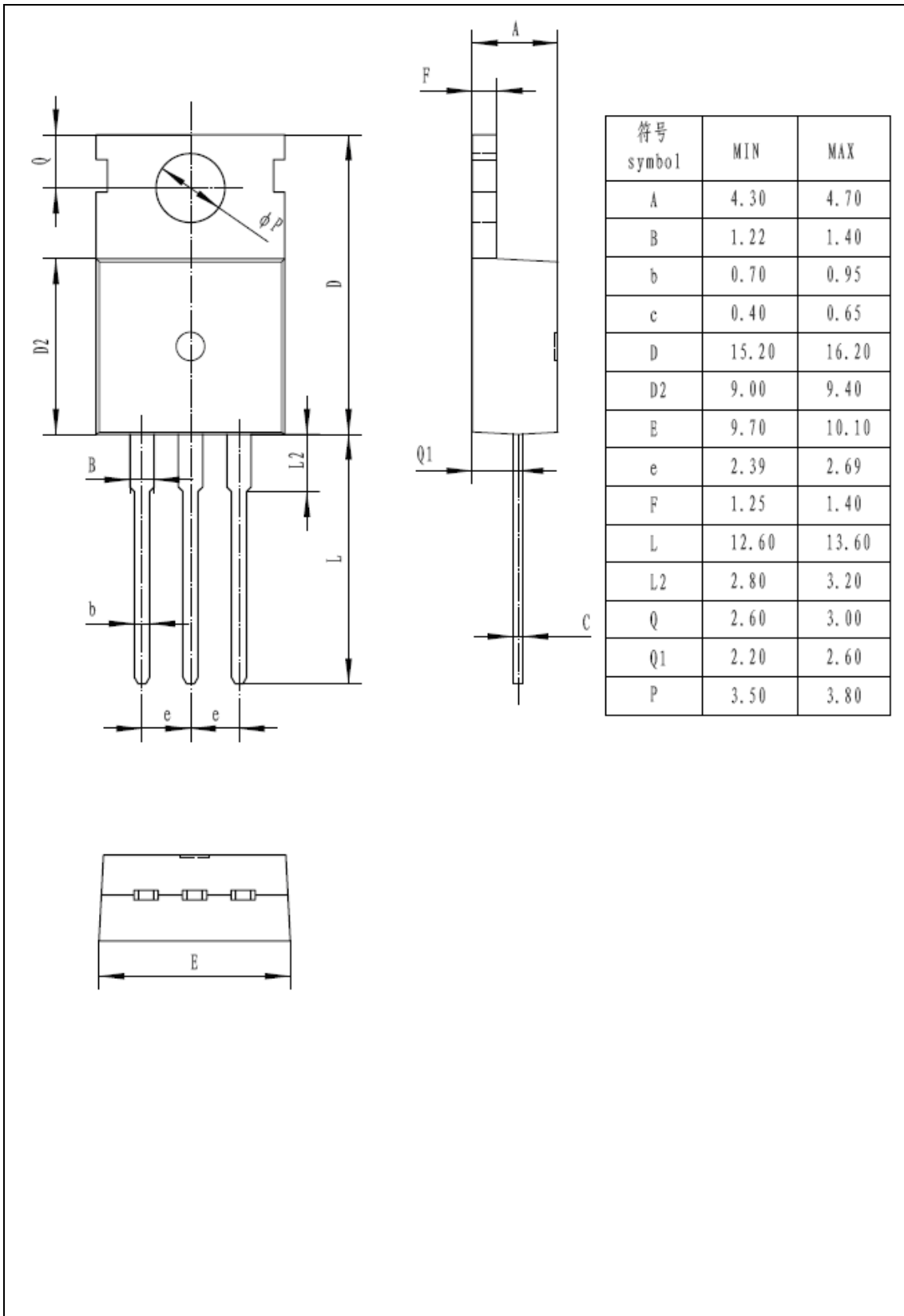



外形尺寸 PACKAGE MECHANICAL DATA

TO-220S

单位 Unit : mm

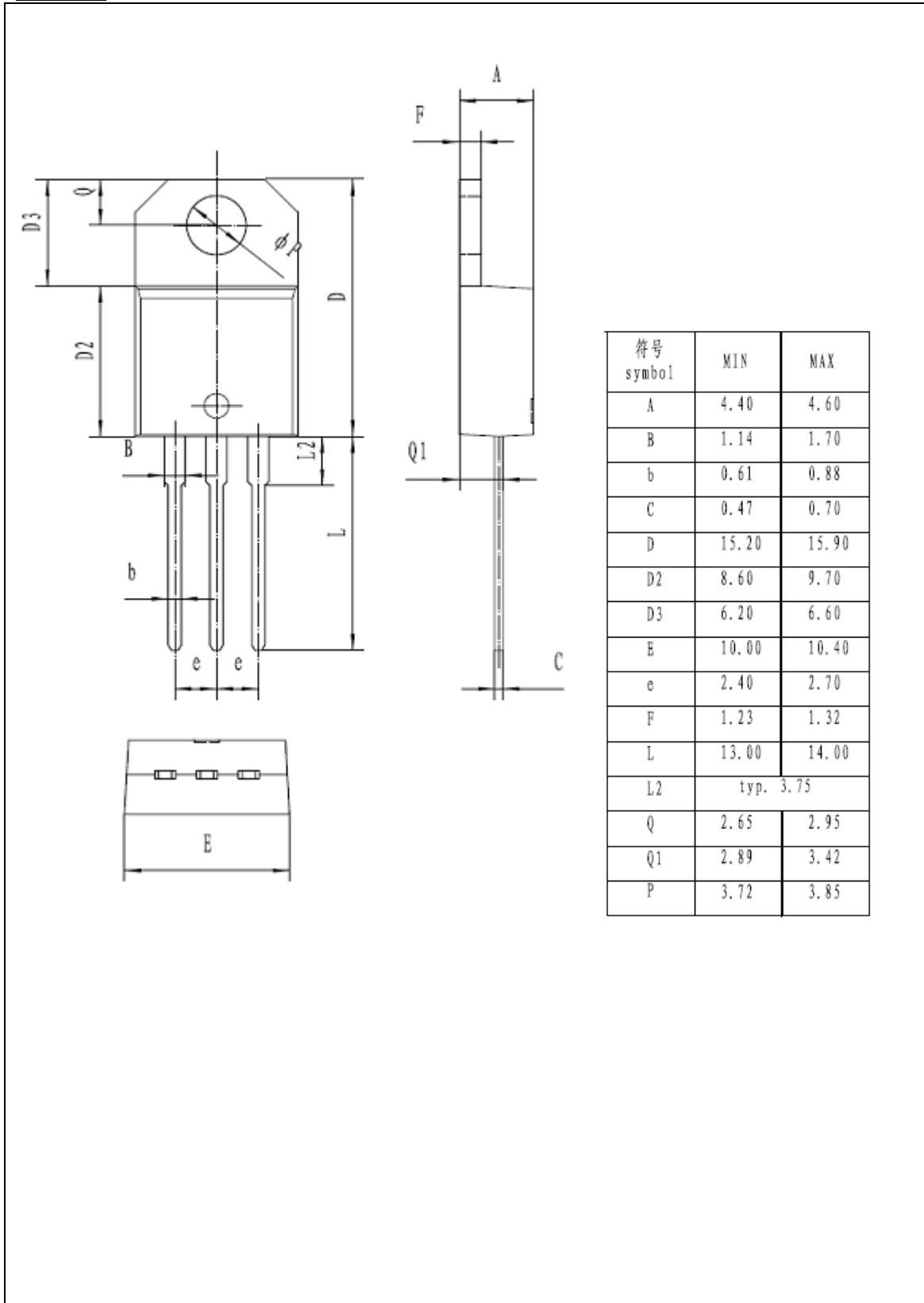



## 外形尺寸 PACKAGE MECHANICAL DATA

TO-220MF-K1

单位 Unit : mm

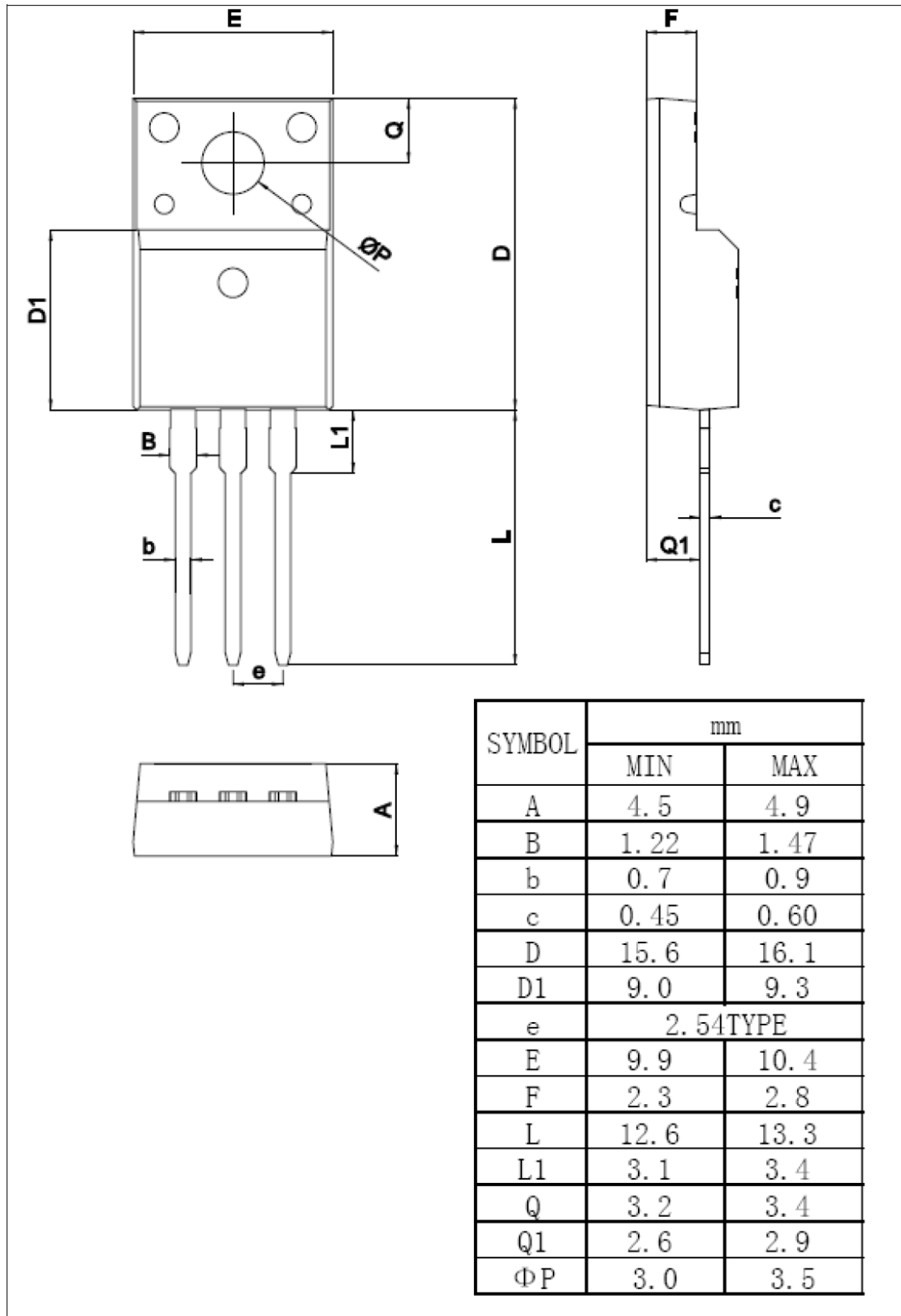



## 外形尺寸 PACKAGE MECHANICAL DATA

TO-263

单位 Unit : mm

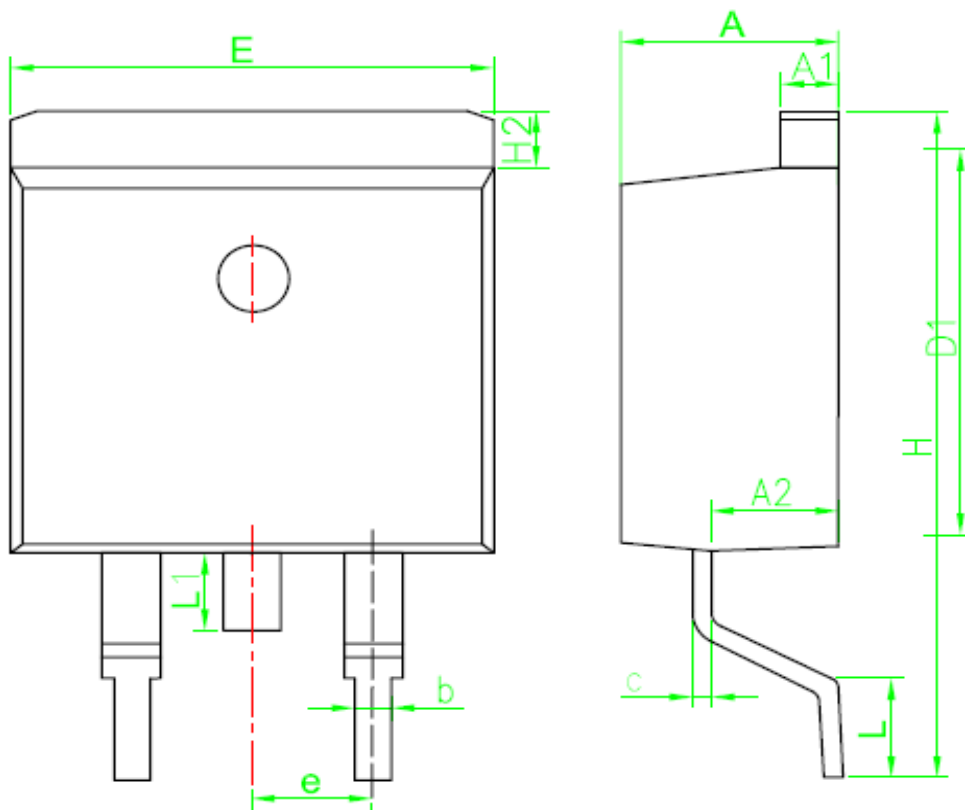

SYMBOL	MM	
	MIN	MAX
A	4.30	4.80
A1	1.12	1.42
A2	2.54	2.84
b	0.67	1.00
c	0.29	0.52
D1	8.40	9.00
E	9.80	10.46
e	2.54BSC	
H	14.00	16.00
H2	1.12	1.45
L	1.50	3.10
L1	1.45	1.70





### 注意事项

1. 吉林华微电子股份有限公司的产品销售分为直销和销售代理，无论哪种方式，订货时请与公司核实。
2. 购买时请认清公司商标，如有疑问请与公司本部联系。
3. 在电路设计时请不要超过器件的绝对最大额定值，否则会影响整机的可靠性。
4. 本说明书如有版本变更不另外告知。

### NOTE

1. Jilin Sino-microelectronics co., Ltd sales its product either through direct sales or sales agent , thus, for customers, when ordering , please check with our company.
2. We strongly recommend customers check carefully on the trademark when buying our product, if there is any question, please don't be hesitate to contact us.
3. Please do not exceed the absolute maximum ratings of the device when circuit designing.
4. Jilin Sino-microelectronics co., Ltd reserves the right to make changes in this. specification sheet and is subject to change without prior notice.

### 联系方式

#### 吉林华微电子股份有限公司

公司地址：吉林省吉林市深圳街 99 号

邮编：132013

总机：86-432-64678411

传真：86-432-64665812

网址：[www.hwdz.com.cn](http://www.hwdz.com.cn)

### CONTACT

#### JILIN SINO-MICROELECTRONICS CO., LTD.

ADD: No.99 Shenzhen Street, Jilin City, Jilin Province, China.

Post Code: 132013

Tel: 86-432-64678411

Fax: 86-432-64665812

Web Site: [www.hwdz.com.cn](http://www.hwdz.com.cn)